



KDRS

Kommunearkivinstusjonenes
Digitale RessursSenter

KDRS digitalt depot
Del 2 – ESSArch Tools Installasjon
24. januar 2017

ESSArch Tools

I denne delen av kurset skal vi se på

- Import av virtuell maskin med ETP eller ETA i VirtualBox

ETP – ESSArch Tools for Producer (sone 1)

ETA – ESSArch Tools for Archive (sone 2)

Framgangsmåten er likt for begge.

- Nødvendig lokal tilpassing av ETP og ETA
Mye likt for begge, men noen forskjeller.



KDRS Virtual Appliances med ESSArch Tools

Vi har to stykker:

- KDRS-ETP-0.93.4-20160601.01
ESSArch Tools for Producer
- KDRS-ETA-0.93.1-20160302.01
ESSArch Tools for Archive



KDRS Virtual Appliances med ESSArch Tools

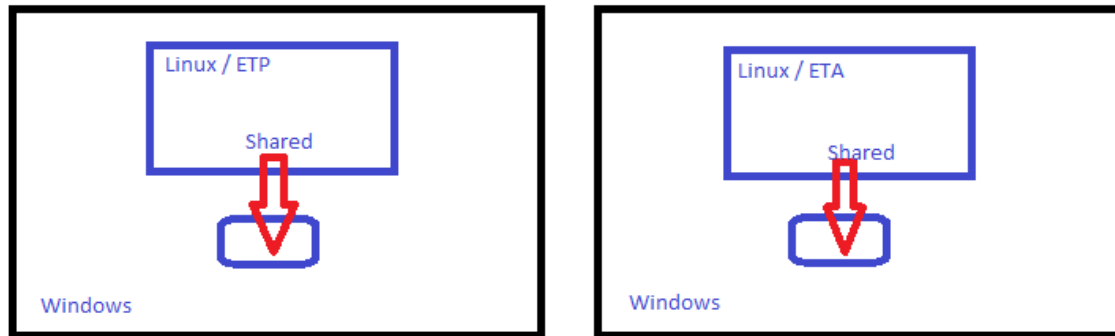

KDRS Virtual Appliances med ESSArch Tools

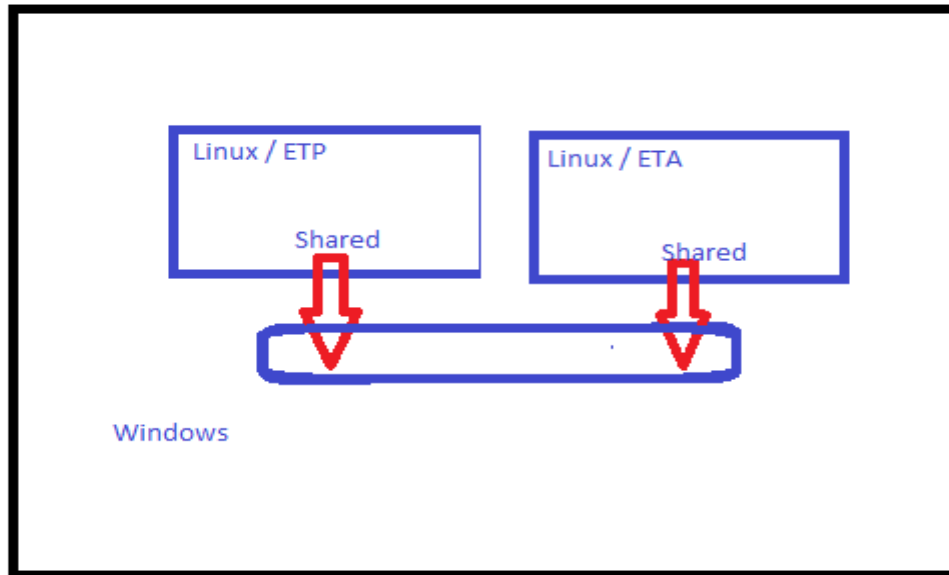

VirtualBox

Dersom du ikke allerede har VirtualBox installert, last det ned fra <https://www.virtualbox.org/wiki/Downloads> og installere.

Link på ressursida på www.kdrs.no



Importere virtuell maskin

- Last ned riktig .ova fil fra vår Google Drive område (Link fra ressursida på www.kdrs.no)
- Start VirtualBox Manager
- I «File» menyen velg «Import Appliance».



Importere virtuell maskin

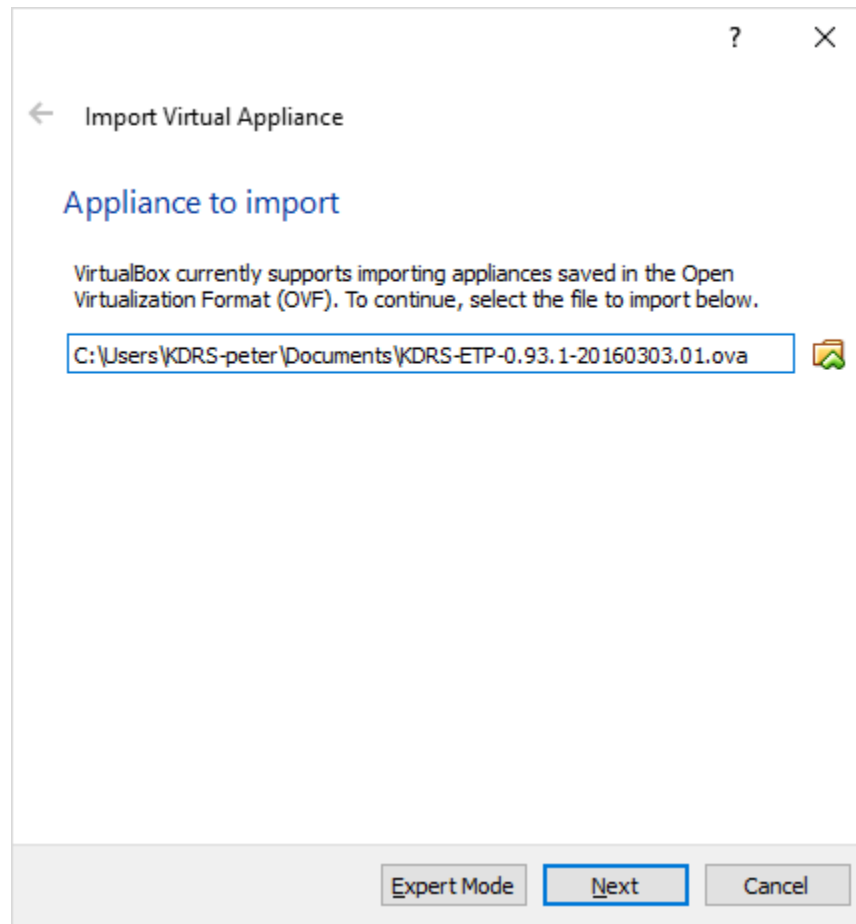

Innstillinger for import

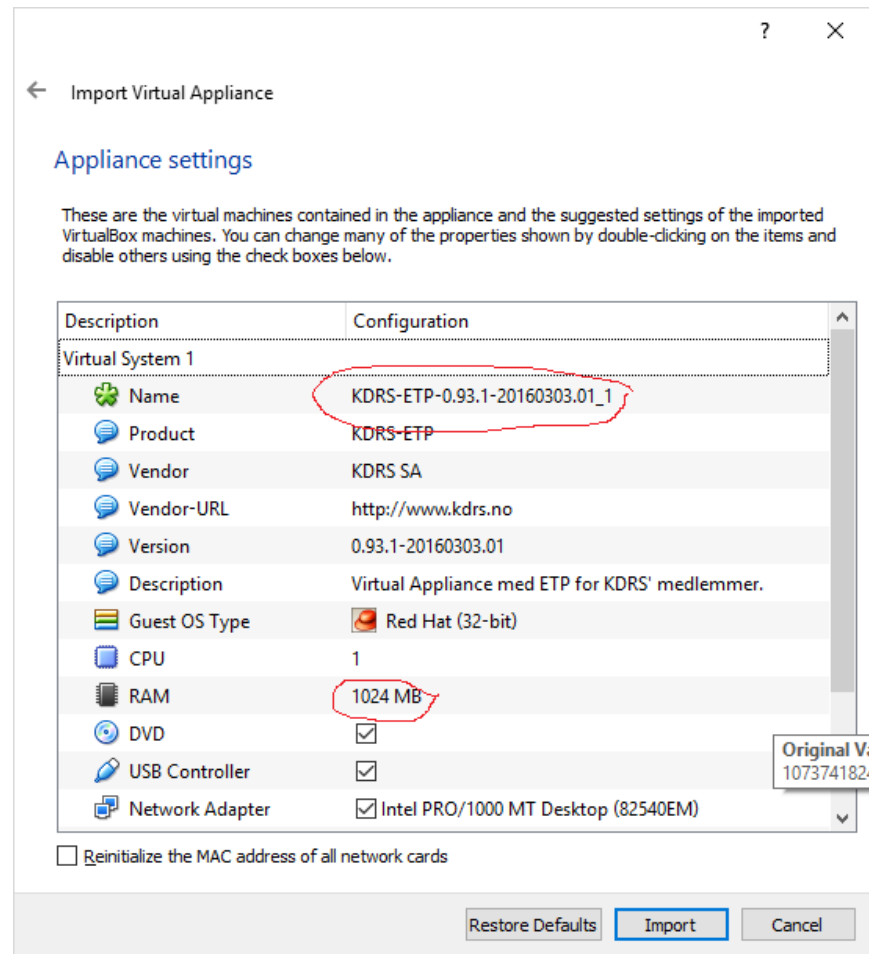

Oppsett av delte mapper

Vi trenger delte mapper mellom virtuell maskin og vertsmaskin til følgende:

- Legge til mappestrukturer i en ny arkivpakke i ETP
- Ta en arkivpakke ut av ETP for overføring til ETA
- Få en mottatt arkivpakke inn i ETA



Oppsett av delte mapper, forts.

The screenshot shows the Oracle VM VirtualBox Manager interface. On the left, a list of virtual machines is displayed, with 'Test-ETP-0.93.1-20160303.01' selected. The main window shows the settings for this VM, with the 'Shared folders' section circled in red. The 'Preview' window shows the VM's display output, which is a black screen with the text 'Test-ETP-0.93.1-20160303.01'.

General
Name: Test-ETP-0.93.1-20160303.01
Operating System: Red Hat (32-bit)

System
Base Memory: 1024 MB
Boot Order: Floppy, Optical, Hard Disk
Acceleration: PAE/NX, KVM Paravirtualization

Display
Video Memory: 15 MB
Remote Desktop Server: Disabled
Video Capture: Disabled

Storage
Controller: IDE
IDE Secondary Master: [Optical Drive] Empty
Controller: SCSI
SCSI Port 0: KDRS-ETP-0.93.1-20160303.01-disk1.vmdk (Normal, 60,00 GB)

Audio
Disabled

Network
Adapter 1: Intel PRO/1000 MT Desktop (NAT)

USB
USB Controller: OHCI
Device Filters: 0 (0 active)

Shared folders
None

Description
Virtual Appliance med ETP for KDRS' medlemmer.



Oppsett av delte mapper, forts.

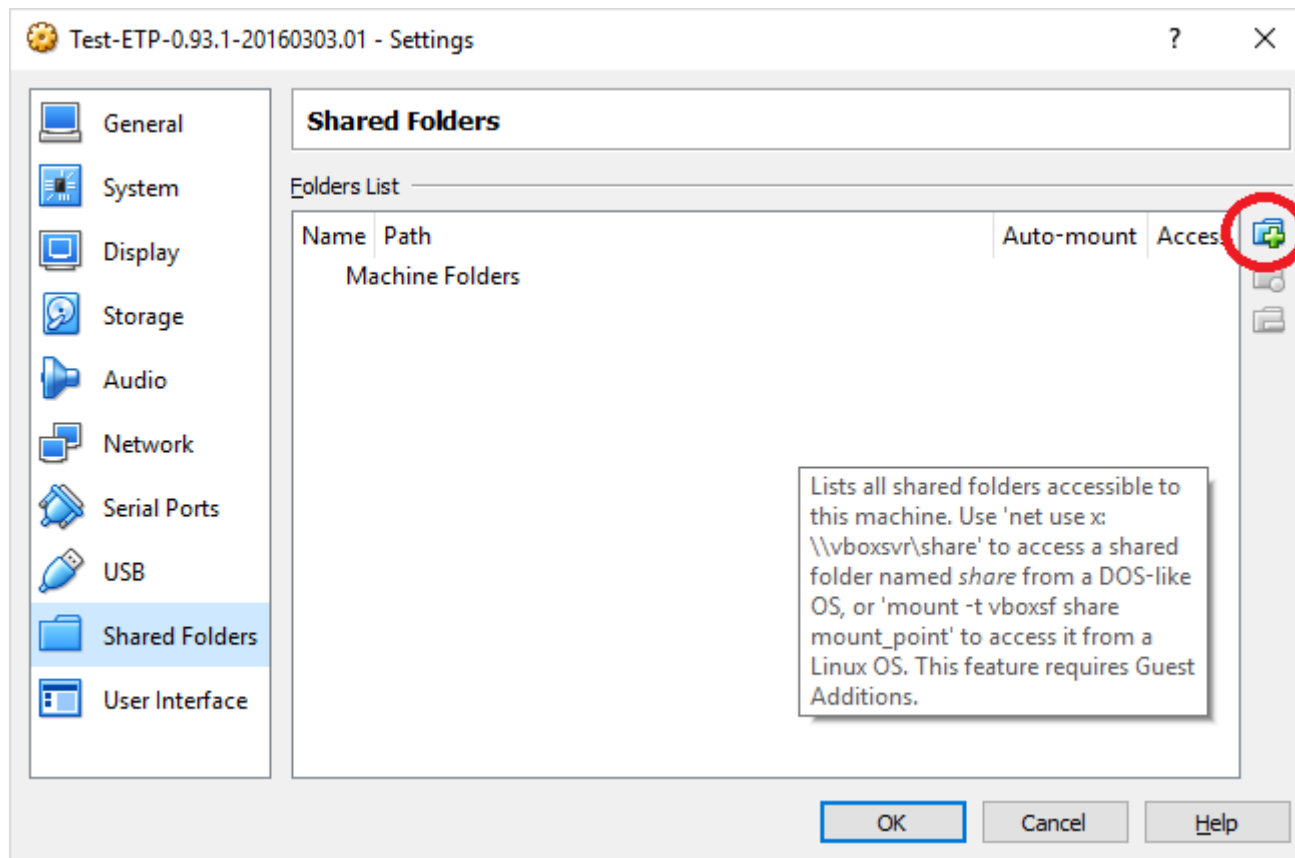

Oppsett av delte mapper, forts.

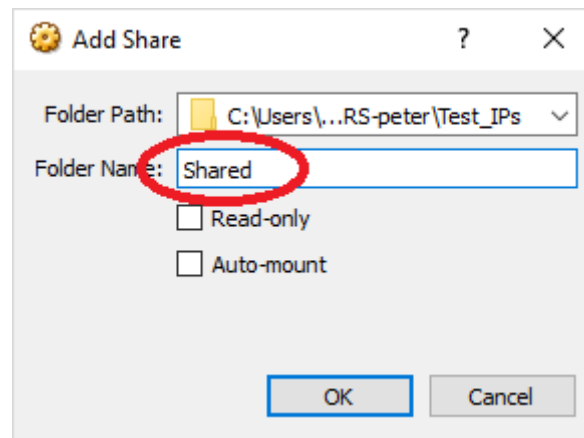

Oppsett av delte mapper, forts.

- Gjenta prosedyren for «Prepare» for ETP

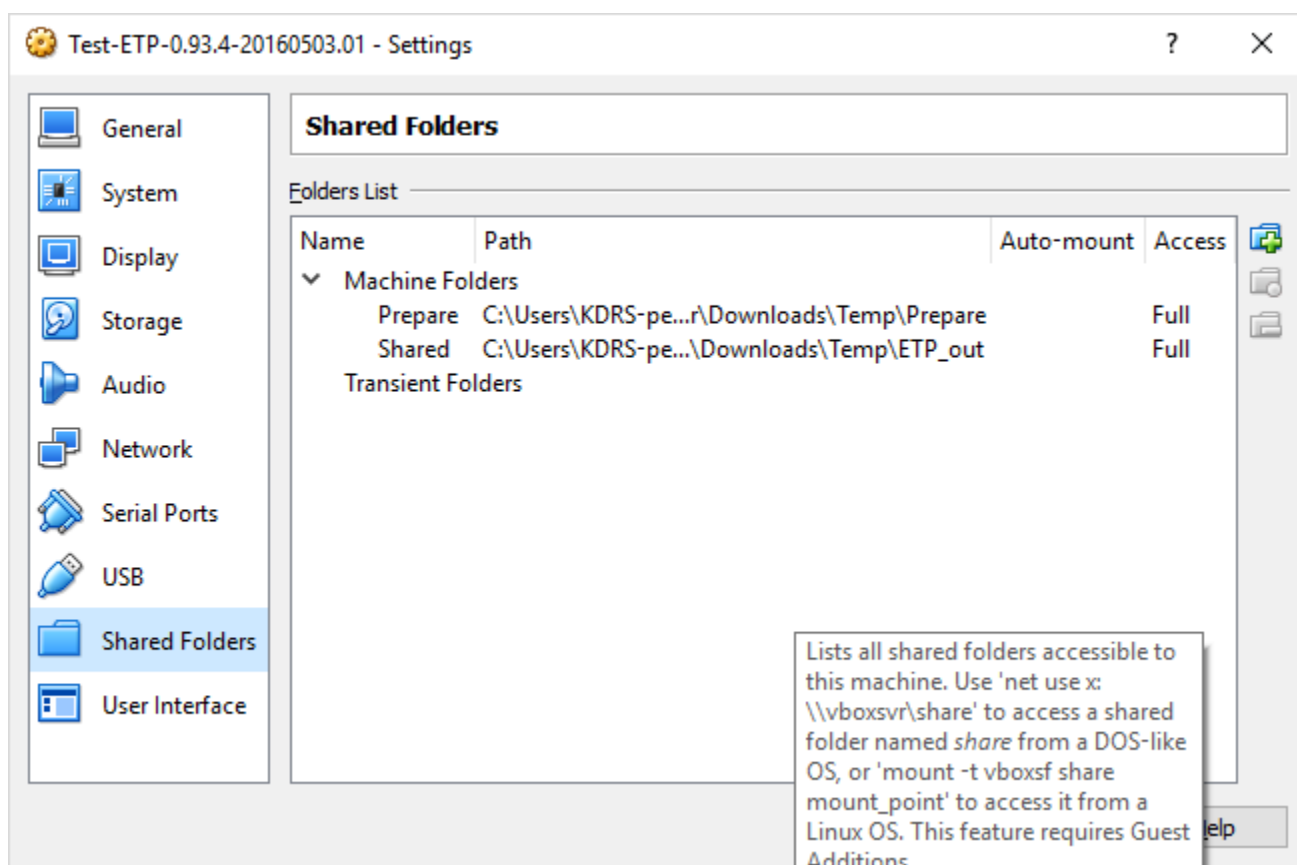

Tilpasning av nettverk

- Annet på maskin med ETP som også bruker port 443 (Skype?)
- Dersom man skal ha en kopi av ETP på samme maskin som ETA



Tilpasning av nettverk, forts.

The screenshot displays the Oracle VM VirtualBox Manager interface. On the left, a list of virtual machines is shown, with 'Test-ETP-0.93.1-20160303.01' selected and highlighted in blue. The main window shows the settings for this VM, with the 'Network' tab selected and circled in red. The 'Network' settings show 'Adapter 1: Intel PRO/1000 MT Desktop (NAT)'. Other tabs visible include General, System, Display, Storage, Audio, USB, Shared folders, and Description. The 'General' tab shows the VM name 'Test-ETP-0.93.1-20160303.01' and operating system 'Red Hat (32-bit)'. The 'System' tab shows base memory of 1024 MB and boot order: Floppy, Optical, Hard Disk. The 'Display' tab shows video memory of 15 MB. The 'Storage' tab shows a SCSI controller with a disk 'KDRS-ETP-0.93.1-20160303.01-disk1.vmdk (Normal, 60,00 GB)'. The 'Audio' tab is disabled. The 'USB' tab shows a USB controller 'OHCI' with 0 active device filters. The 'Shared folders' tab shows 1 shared folder. The 'Description' tab shows 'Virtual Appliance med ETP for KDRS' medlemmer.



Tilpasning av nettverk, forts.

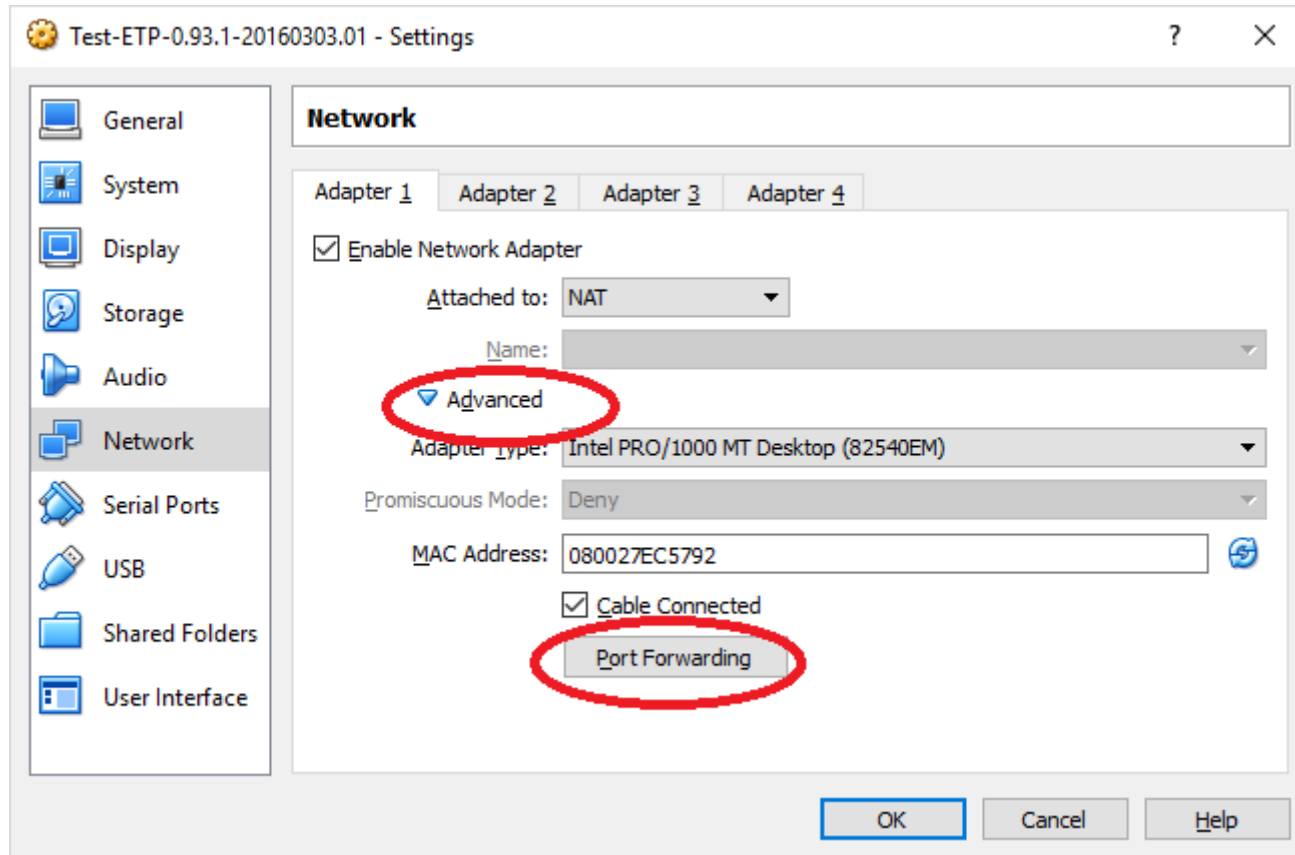

Tilpasning av nettverk, forts.

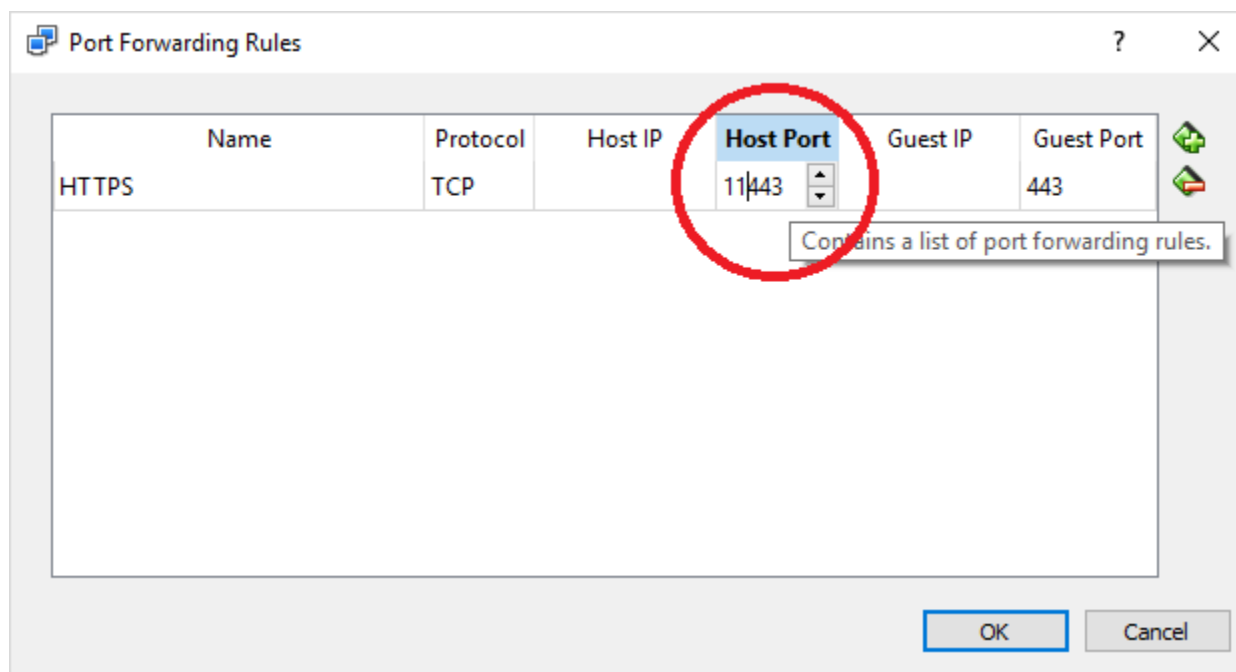

ESSArch tools tilpassing og brukeradministrasjon

- <https://localhost> evt. <https://localhost:<port>>

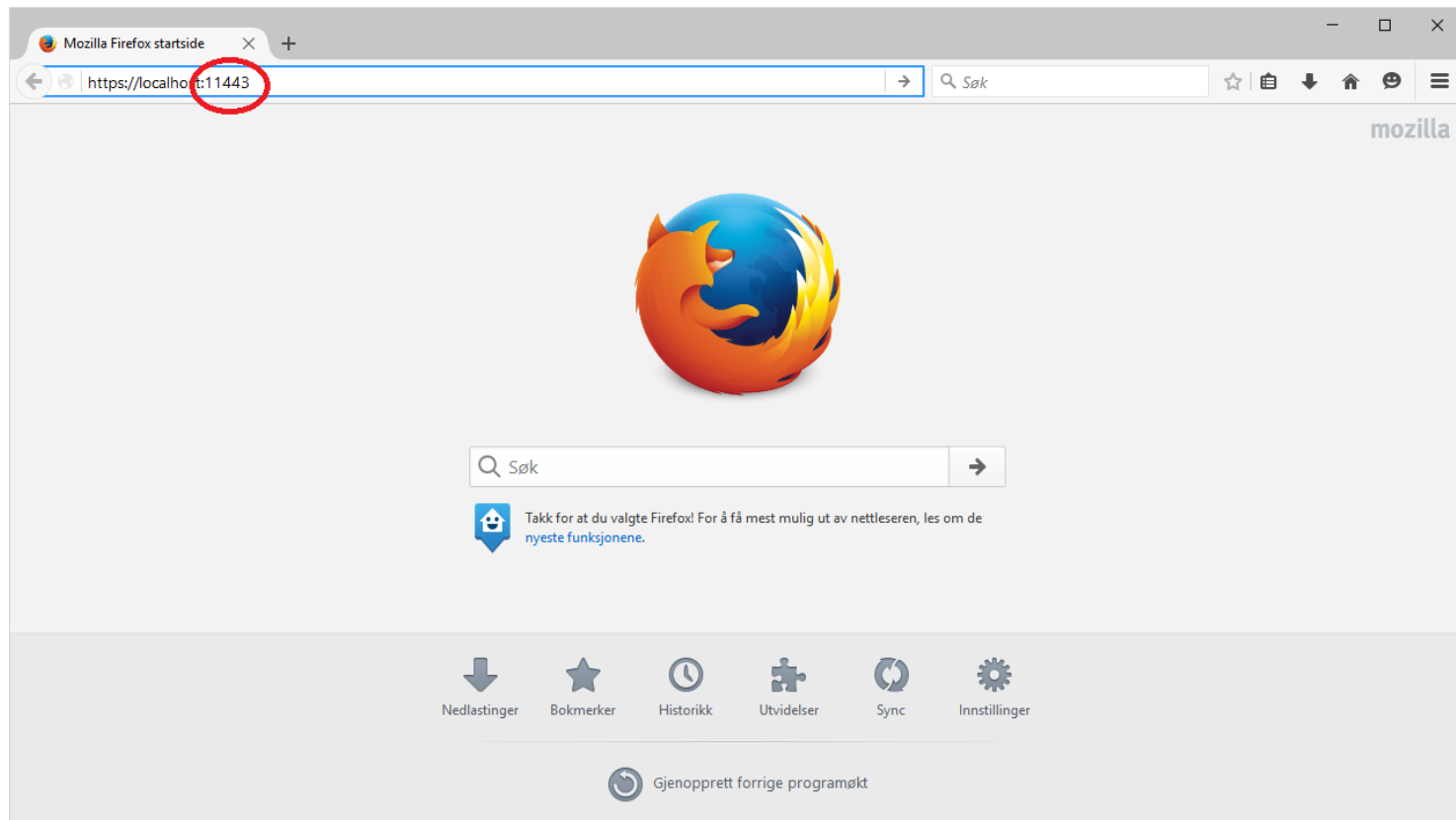

ESSArch tools tilpassing og brukeradministrasjon

- Standard pålogging første gang er
bruker: admin passord: admin
- Nødvendig tilpasninger før vi begynner:
 - Brukeradministrasjon
 - E-Postadresse til postmottak (ETP)
 - Dataoverføringsadresse (ETA)



Brukeradministrasjon

The screenshot shows a web browser window with the address bar displaying `https://localhost:11443`. The page title is "ESSArch Tools for Producer". The user is logged in as "admin @ zone1" and can click "Change password / Log out". The navigation menu includes "INFORMATION PACKAGE", "LOG EVENTS", "MANAGEMENT", and "Hjelp". The "MANAGEMENT" menu is highlighted with a red circle, and its dropdown options are "Information Packages" and "Configuration". The status bar at the bottom shows `https://localhost:11443/admin`.



Brukeradministrasjon, forts.

The screenshot shows the administration interface for ESSArch Tools for Producer. The browser address bar indicates the URL is `https://localhost:11443/admin/`. The page title is "ESSArch Tools for Producer" and the user is logged in as "admin @".

The main content area is titled "Site administration" and is organized into several sections:

- Authentication and Authorization:**
 - Groups:** Add, Change
 - Users:** Add (circled in red), Change
- Configuration:**
 - Ip parameters:** Add, Change
 - Log Events:** Add, Change
 - Parameters:** Add, Change
 - Paths:** Add, Change
 - XML Schemas:** Add, Change
- Ip:**
 - Information packages:** Add, Change
- Profiles:**
 - Agent profiles:** Add, Change
 - Classification profiles:** Add, Change
 - Data selection profiles:** Add, Change
 - Import profiles:** Add, Change
 - Transfer project profiles:** Add, Change

On the right side, there is a "Recent Actions" panel with the following content:

- Recent Actions
- My Actions
- None available



Brukeradministrasjon, forts.

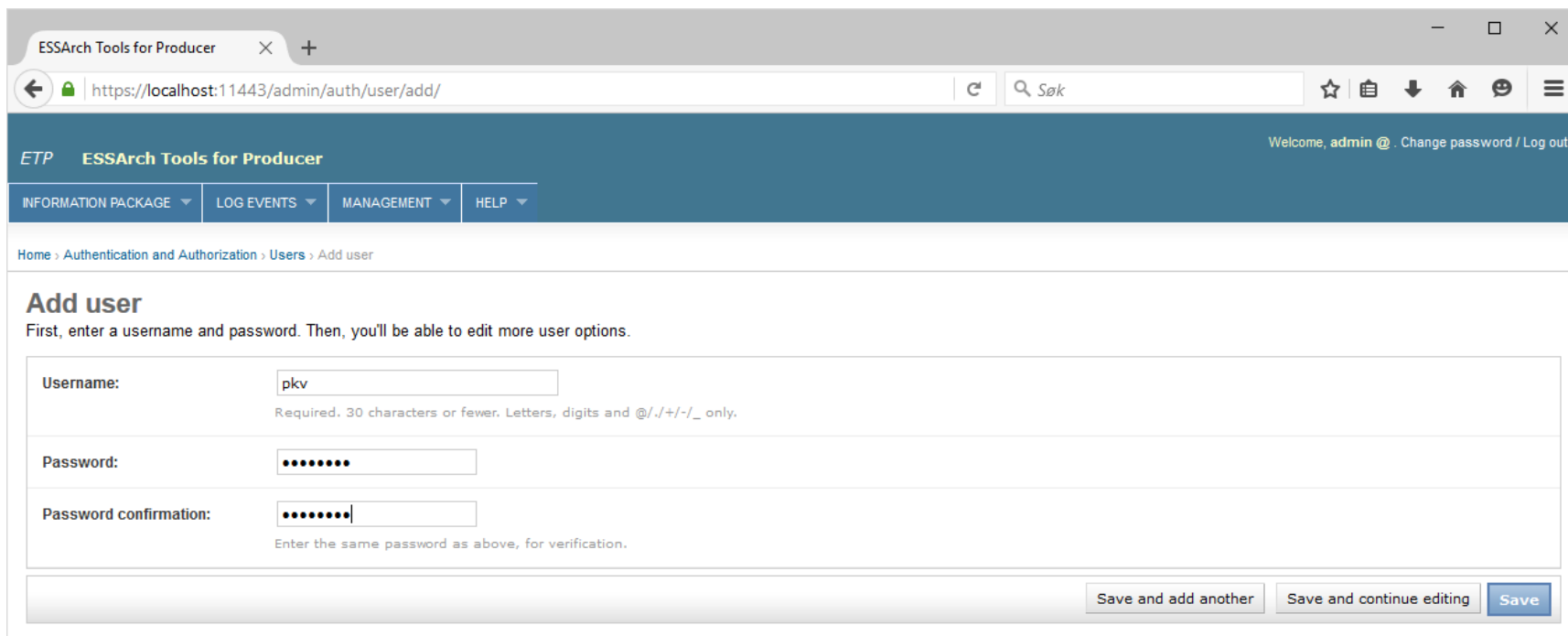

The screenshot shows a web browser window with the URL `https://localhost:11443/admin/auth/user/add/`. The page title is "ESSArch Tools for Producer". The user is logged in as "admin @". The navigation menu includes "INFORMATION PACKAGE", "LOG EVENTS", "MANAGEMENT", and "HELP". The breadcrumb trail is "Home > Authentication and Authorization > Users > Add user".

Add user

First, enter a username and password. Then, you'll be able to edit more user options.

Username:
Required. 30 characters or fewer. Letters, digits and @/./+/-/_ only.

Password:

Password confirmation:
Enter the same password as above, for verification.

Save and add another Save and continue editing Save



Brukeradministrasjon, forts.

ESSArch Tools for Producer

https://localhost:11443/admin/auth/user/3/

The user "pkv" was added successfully. You may edit it again below.

Change user

Username:

Required: 30 characters or fewer. Letters, digits and @/./+/-/_ only.

Password: **algorithm: pbkdf2_sha256 iterations: 20000 salt: pEPYRV***** hash: RSzslly*******

Raw passwords are not stored, so there is no way to see this user's password, but you can change the password using [this form](#).

Personal info

First name:

Last name:

Email address:

Permissions

Active
Designates whether this user should be treated as active. Unselect this instead of deleting accounts.

Staff status
Designates whether the user can log into this admin site.

Superuser status
Designates that this user has all permissions without explicitly assigning them.

Groups

Available groups:

Chosen groups:

The groups this user belongs to. A user will get all permissions granted to each of their groups. Hold down "Control", or "Command" on a Mac, to select more than one.

Choose all Remove all

User permissions

Available user permissions:

Chosen user permissions:

Specific permissions for this user. Hold down "Control", or "Command" on a Mac, to select more than one.

- admin | log entry | Can add log entry
- admin | log entry | Can change log entry
- admin | log entry | Can delete log entry
- auth | group | Can add group
- auth | group | Can change group
- auth | group | Can delete group



Oppsettsparametre

- ETP: epostadresse for oversending av info.xml for nye arkivpakker til postmottak for journalføring.
- ETA: URL for opplasting til EPP
- (ETP: i noen tilfeller kan det være hensiktsmessig med opplasting direkte inn i ETA)
- Standardverdier for IP-parametre (ETP)



Oppsettsparametre, forts.

The screenshot shows the administration interface for ESSArch Tools for Producer. The browser address bar indicates the URL is `https://localhost:11443/admin/`. The page title is "ESSArch Tools for Producer" and the user is logged in as "admin @".

The main content area is titled "Site administration" and is divided into several sections:

- Authentication and Authorization:**
 - Groups: Add, Change
 - Users: Add, Change
- Configuration:**
 - Ip parameters: Add, Change
 - Log Events: Add, Change
 - Parameters: Add, Change** (circled in red)
 - Ports: Add, Change
 - XML Schemas: Add, Change
- Ip:**
 - Information packages: Add, Change
- Profiles:**
 - Agent profiles: Add, Change
 - Classification profiles: Add, Change
 - Data selection profiles: Add, Change
 - Import profiles: Add, Change
 - Transfer project profiles: Add, Change

A "Recent Actions" sidebar on the right shows "My Actions" and "None available".

The browser address bar at the bottom shows the URL: `https://localhost:11443/admin/configuration/parameter/`



Oppsettsparametre, forts. - ETP

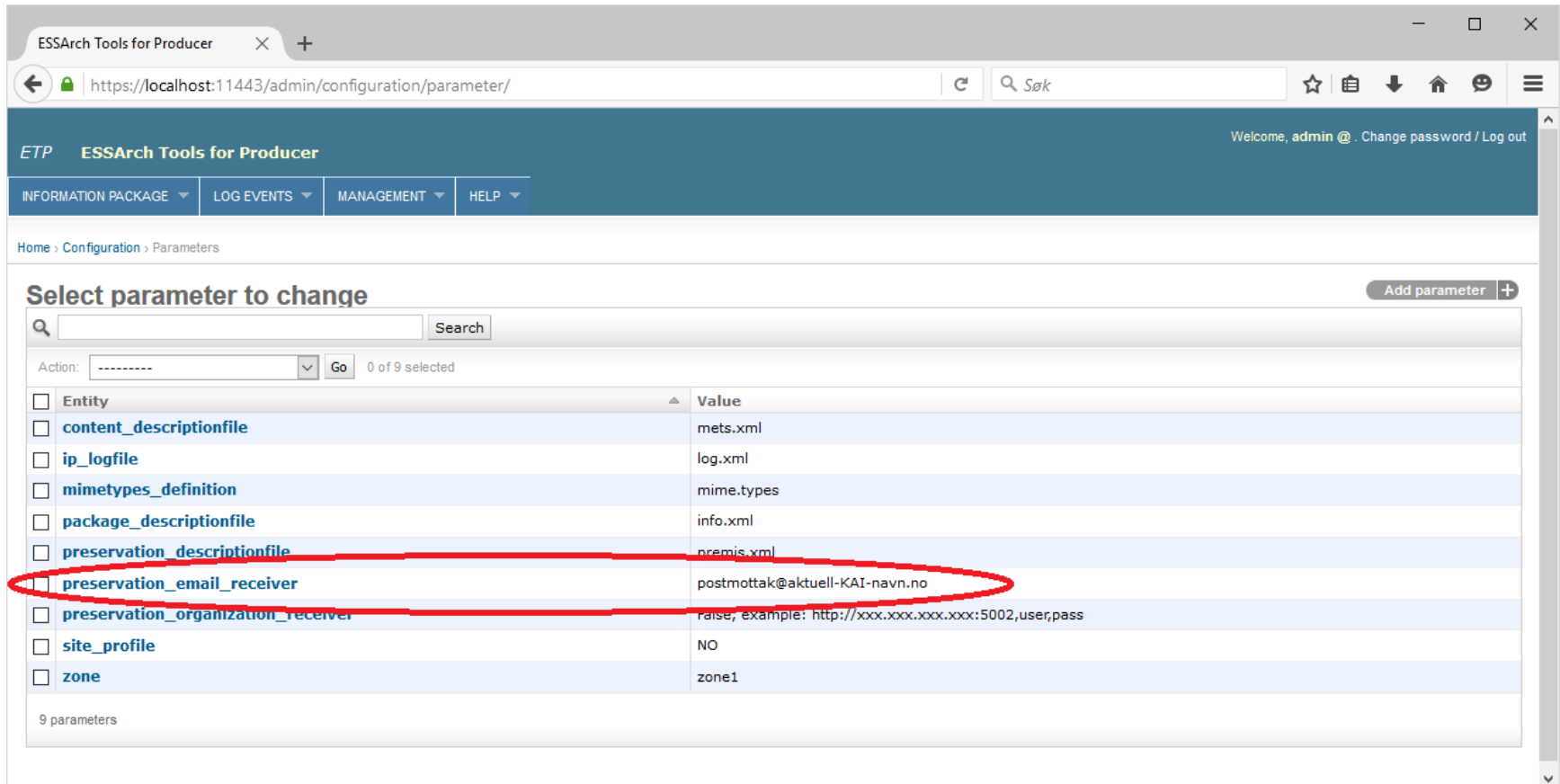

The screenshot shows the 'ESSArch Tools for Producer' configuration interface. The page title is 'Select parameter to change'. There is a search bar and an 'Add parameter' button. Below is a table of parameters with checkboxes for selection. The 'preservation_email_receiver' parameter is circled in red.

Entity	Value
<input type="checkbox"/> content_descriptionfile	mets.xml
<input type="checkbox"/> ip_logfile	log.xml
<input type="checkbox"/> mimetypes_definition	mime.types
<input type="checkbox"/> package_descriptionfile	info.xml
<input type="checkbox"/> preservation_descriptionfile	premis.xml
<input type="checkbox"/> preservation_email_receiver	postmottak@aktuell-KAI-navn.no
<input type="checkbox"/> preservation_organization_receiver	raise, example: http://xxx.xxx.xxx.xxx:5002,user,pass
<input type="checkbox"/> site_profile	NO
<input type="checkbox"/> zone	zone1

9 parameters



Oppsettsparametre, forts.

The screenshot shows the 'ESSArch Tools for Producer' configuration interface. The page title is 'Select parameter to change'. There is a search bar and a table of parameters. The 'preservation_organization_receiver' parameter is highlighted with a red oval.

Entity	Value
<input type="checkbox"/> content_descriptionfile	mets.xml
<input type="checkbox"/> ip_logfile	log.xml
<input type="checkbox"/> mimetypes_definition	mime.types
<input type="checkbox"/> package_descriptionfile	info.xml
<input type="checkbox"/> preservation_descriptionfile	premis.xml
<input type="checkbox"/> preservation_email_receiver	postmottak@aktuell-KAI-nayn.no
<input checked="" type="checkbox"/> preservation_organization_receiver	False, example: http://xxx.xxx.xxx.xxx:5002,user,pass
<input type="checkbox"/> site_profile	NO
<input type="checkbox"/> zone	zone1

9 parameters



Oppsettsparametre, forts. - ETP

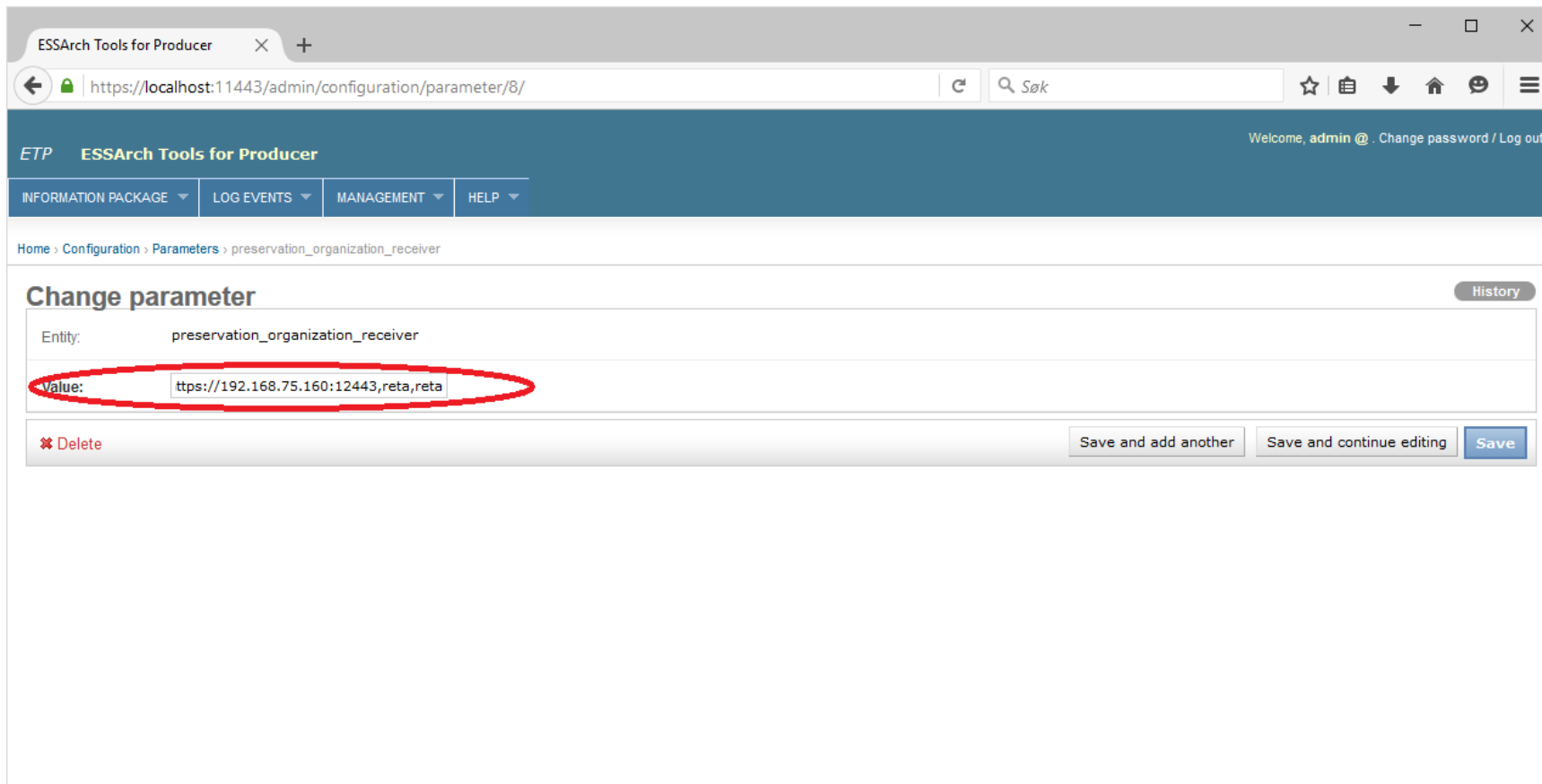

The screenshot shows a web browser window with the URL `https://localhost:11443/admin/configuration/parameter/8/`. The page title is "ESSArch Tools for Producer". The user is logged in as "admin @". The page displays the configuration for the parameter "preservation_organization_receiver". The "Value" field is highlighted with a red oval and contains the text `https://192.168.75.160:12443,reta,reta`. The page includes a "Delete" button and three "Save" buttons: "Save and add another", "Save and continue editing", and "Save".

ESSArch Tools for Producer

Welcome, admin @ . Change password / Log out

INFORMATION PACKAGE LOG EVENTS MANAGEMENT HELP

Home > Configuration > Parameters > preservation_organization_receiver

Change parameter

Entity: preservation_organization_receiver

Value: `https://192.168.75.160:12443,reta,reta`

Delete Save and add another Save and continue editing Save



Oppsettsparametre, forts. - ETA

The screenshot shows the 'Parameters' configuration page in the ESSArch Tools for Archive interface. The page title is 'Select parameter to change'. There is a search bar and an 'Add parameter' button. Below is a table of parameters with checkboxes for selection. The 'preservation_organization_receiver' parameter is circled in red.

Entity	Value
<input type="checkbox"/> content_descriptionfile	mets.xml
<input type="checkbox"/> ip_logfile	log.xml
<input type="checkbox"/> mimetypes_definition	mime.types
<input type="checkbox"/> package_descriptionfile	info.xml
<input type="checkbox"/> preservation_descriptionfile	premis.xml
<input type="checkbox"/> preservation_email_receiver	receiver@archive.xxx
<input checked="" type="checkbox"/> preservation_organization_receiver	https://essarch-test.kdrs.no,ESSArch1_upload,ESSArch1_A1
<input type="checkbox"/> site_profile	NO
<input type="checkbox"/> zone	zone2

9 parameters



Oppsettsparametre, forts.

Adresser for kurset

- ESSArch2:
https://essarch2.kdrs.no,ESSArch2_upload,ESSArch2_A2
- ESSArch3
https://essarch3.kdrs.no,ESSArch3_upload,ESSArch3_A3
- ESSArch4:
https://essarch4.kdrs.no,ESSArch4_upload,ESSArch4_A0



IP Parametre

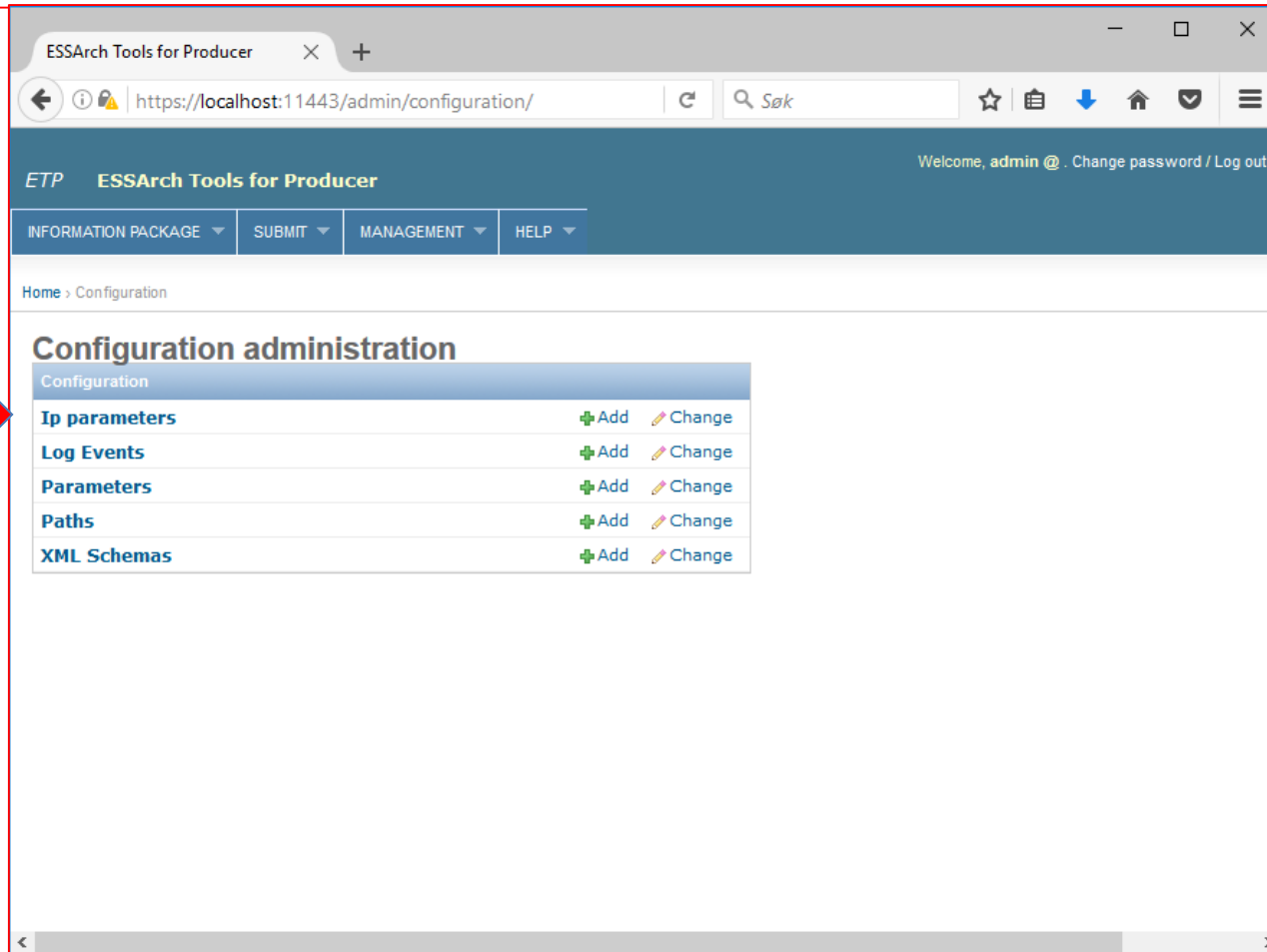

The screenshot shows a web browser window with the URL `https://localhost:11443/admin/configuration/`. The page title is "ESSArch Tools for Producer". The user is logged in as "admin @". The navigation menu includes "INFORMATION PACKAGE", "SUBMIT", "MANAGEMENT", and "HELP". The breadcrumb trail is "Home > Configuration". The main content area is titled "Configuration administration" and contains a table of configuration items:

Configuration	
Ip parameters	+ Add Change
Log Events	+ Add Change
Parameters	+ Add Change
Paths	+ Add Change
XML Schemas	+ Add Change

A large red arrow points to the "Ip parameters" row in the table.



IP Parametre, forts.

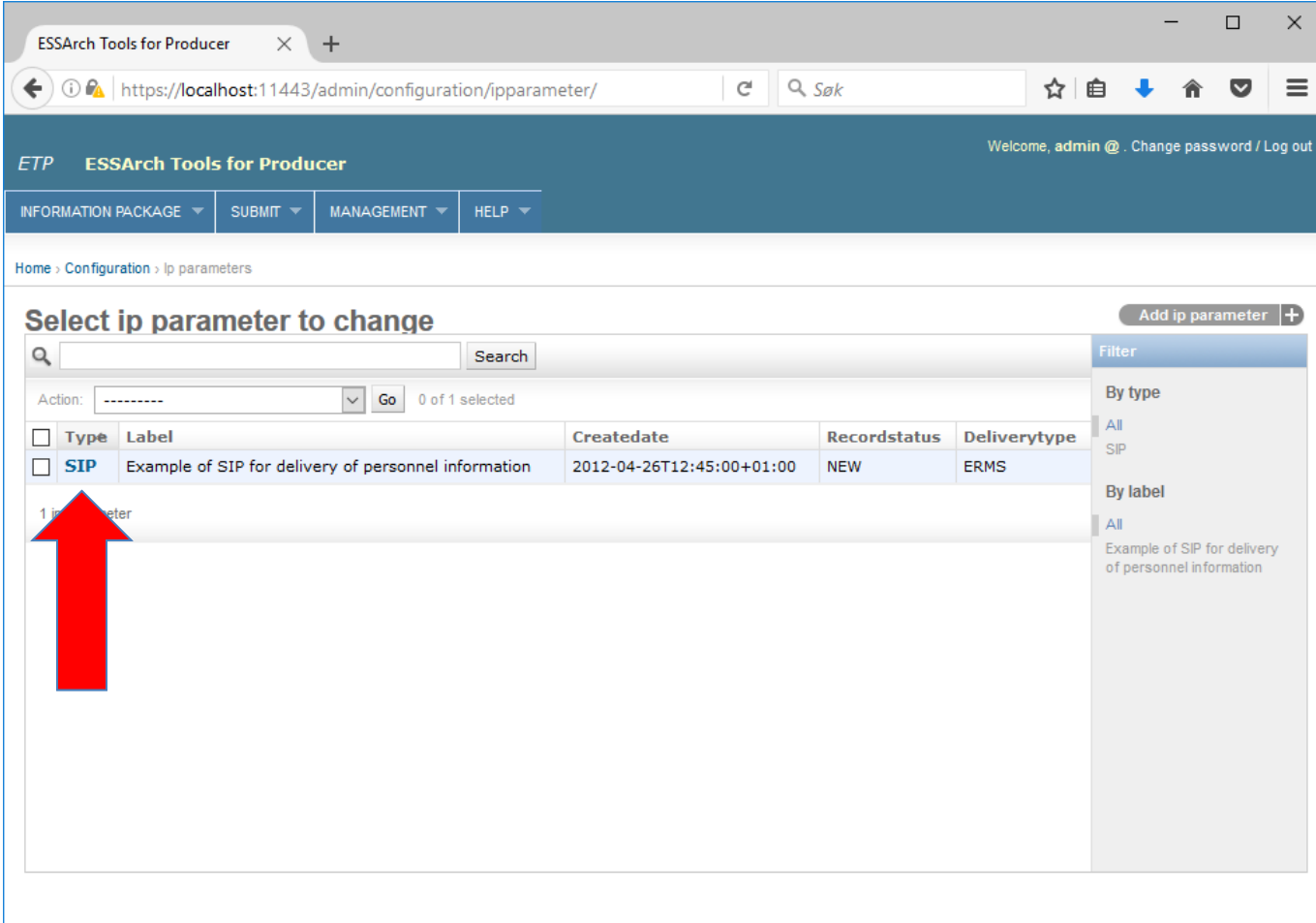

The screenshot shows a web browser window with the URL `https://localhost:11443/admin/configuration/ipparameter/`. The page title is "ESSArch Tools for Producer". The user is logged in as "admin @". The page displays a table of IP parameters with the following data:

Type	Label	Createdate	Recordstatus	Deliverytype
<input type="checkbox"/> SIP	Example of SIP for delivery of personnel information	2012-04-26T12:45:00+01:00	NEW	ERMS

A red arrow points to the "SIP" entry in the table. The page also includes a search bar, a filter sidebar, and a "Add ip parameter" button.



IP Parametre, forts.

The screenshot shows a web browser window with the URL `https://localhost:11443/admin/configuration/ipparameter/1/`. The page title is "ESSArch Tools for Producer". The user is logged in as "admin @". The navigation menu includes "INFORMATION PACKAGE", "SUBMIT", "MANAGEMENT", and "HELP". The breadcrumb trail is "Home > Configuration > Ip parameters > SIP".

Change ip parameter

History

Label:	Example of SIP for delivery of person
Type:	SIP
Objid:	UUID:550e8400-e29b-41d4-a716-446655440004
Createdate:	2012-04-26T12:45:00+01:00
Recordstatus:	NEW
Deliverytype:	ERMS

General metadata for information package ([Show](#))

Metadata for Archivist organization ([Show](#))

Metadata for Creator organization ([Show](#))

Metadata for Producer organization ([Show](#))

Metadata for Submitter organization ([Show](#))

A large red arrow points to the "General metadata for information package (Show)" section.



KDRS-KAI ESSARch oppsett

https://docs.google.com/spreadsheets/d/1N3RgxnGjFn-DllUfdmolrq_IVfYlh5f5bU4QyLXG-s/edit#gid=128647248

ET-1	ET-2	IKAMR ESSArch Tools	IKAR ESSArch Tools	IP parameters	IKAMR ESSArch Tools settings	IKAR ESSArch Tools settings	Mal	Mets SIP	Mets AIP	DI/
				(management/configuration/ip parameters) Informasjon om roller knyttet til arkiv og leveranse						
				Change ip parameter						
ET02	A01	1315_1 Symfoni (1998-2006)	1102_1 DocuLive (1999-1999)	Label (tror ikke denne har en funksjon)	11KR_N <system> (fra-til år)	11KR_N <system> (fra-til år)	FFKK_N <system> {(fra-til)			
	A02			Type	SIP	SIP	SIP			
	A03			Objid	<UUID som ikke kan endres>	<UUID som ikke kan endres>	<UUID som ikke kan endres>			
	A04			Createdate	2016-10-28T14:26:00+01:00	2016-10-28T14:26:00+01:00	2016-10-28T14:26:00+01:00	x	x	
	A05			Recordstatus	NEW	NEW	NEW	x		
	A06	Default = ?	> Opptrer i AIP-METS (betyr?)	Deliverytype	Ikke i bruk	Ikke i bruk	Ikke i bruk		x	
				General metadata for information package						
	B01	Default = ?	> Opptrer i AIP-METS (betyr?)	Deliveryspecifcation	Ikke i bruk	Ikke i bruk	Ikke i bruk			x
ET03	B02	IKAMR 16/1715-3, 2016-10-17	IKAR 16/saknr-doknr; yyyy-mm-dd	Submissionagreement	IKAMR 16/saknr-jp; yyyy-mm-dd	IKAR 16/saknr-doknr; yyyy-mm-dd	<KA> yy/saknr-doknr; yyyy-mm-dd	x	x	
	B03			Systemtype	KOARK	NOARK-4	NOARK-<versj>/fagsystem			x
	B04			Previousubmissionagreement	Ikke i bruk	Ikke i bruk	Ikke i bruk			
	B05			Datasubmissionsession	Ikke i bruk	Ikke i bruk	Ikke i bruk			
	B06			Packagenumber	Ikke i bruk	Ikke i bruk	Ikke i bruk			
	B07			Referencecode	Ikke i bruk	Ikke i bruk	Ikke i bruk			
	B08			Previousreferencecode	Ikke i bruk	Ikke i bruk	Ikke i bruk			
	B09			Appraisal	Ikke i bruk	Ikke i bruk	Ikke i bruk			
	B10			Accessrestrict	Ikke i bruk	Ikke i bruk	Ikke i bruk			
ET04	B11	1996-08-18	1999-02-12	Startdate	yyyy-mm-dd	yyyy-mm-dd	yyyy-mm-dd	x	x	
ET05	B12	2006-12-31	2007-05-20	Enddate	yyyy-mm-dd	yyyy-mm-dd	yyyy-mm-dd	x	x	
	B13	Default = 1	> Opptrer i AIP-METS (betyr?)	Informationclass ?						x
	B14			Comments?	Ikke i bruk	Ikke i bruk	Ikke i bruk			x
				Metadata for Archivist organization	Arkivskaper til SIP					Ark
ET01	C01	1175 Hesty Kommune	1102 Sandnes Kommune	Archivist organization name	Systemubvisningsnavn	Systemubvisningsnavn	kommunenr./orgnr. + navn	x	x	
	C02			Archivist organization id	1515	1102 (kommer trolig ikke med iht. METS?)	kommunenr./orgnr			
ET06	C03	Cinet Symfoni	1102_1 DocuLive	Archivist organization software	Systemnavn	Systemnavn	Systemnavn	x	x	
ET07	C04	4.3	Ukjent	Archivist organization software id	<versjon nr>/Ukjent	<versjon nr>/Ukjent	<versjon nr>/Ukjent	x	x	
ET08	C05	Lotus Notes/Lotus Domino	MSSQL-server	Archivist organization software type	DB-plattform	DB-plattform	Database/Server platform	x	x	
	C06			Archivist organization software type version	6.5	2000	<versjon nr>/Ukjent			
	C07			Archivist individual	Ikke i bruk	Ikke i bruk	Ikke i bruk			
	C08			Archivist individual telephone	Ikke i bruk	Ikke i bruk	Ikke i bruk			
	C09			Archivist individual email	Ikke i bruk	Ikke i bruk	Ikke i bruk			
				Metadata for Creator organization	METS-creator/Metadata ansvar					ME
ET09	D01	Interkommunalt Arkiv for Mar	Sandnes kommune	Creator organization	Teknisk skaper av METS-dokument	Teknisk produsent av METS-dokument	Teknisk produsent av METS-dokument	x	x	



Avslutte ESSArch Tools VM

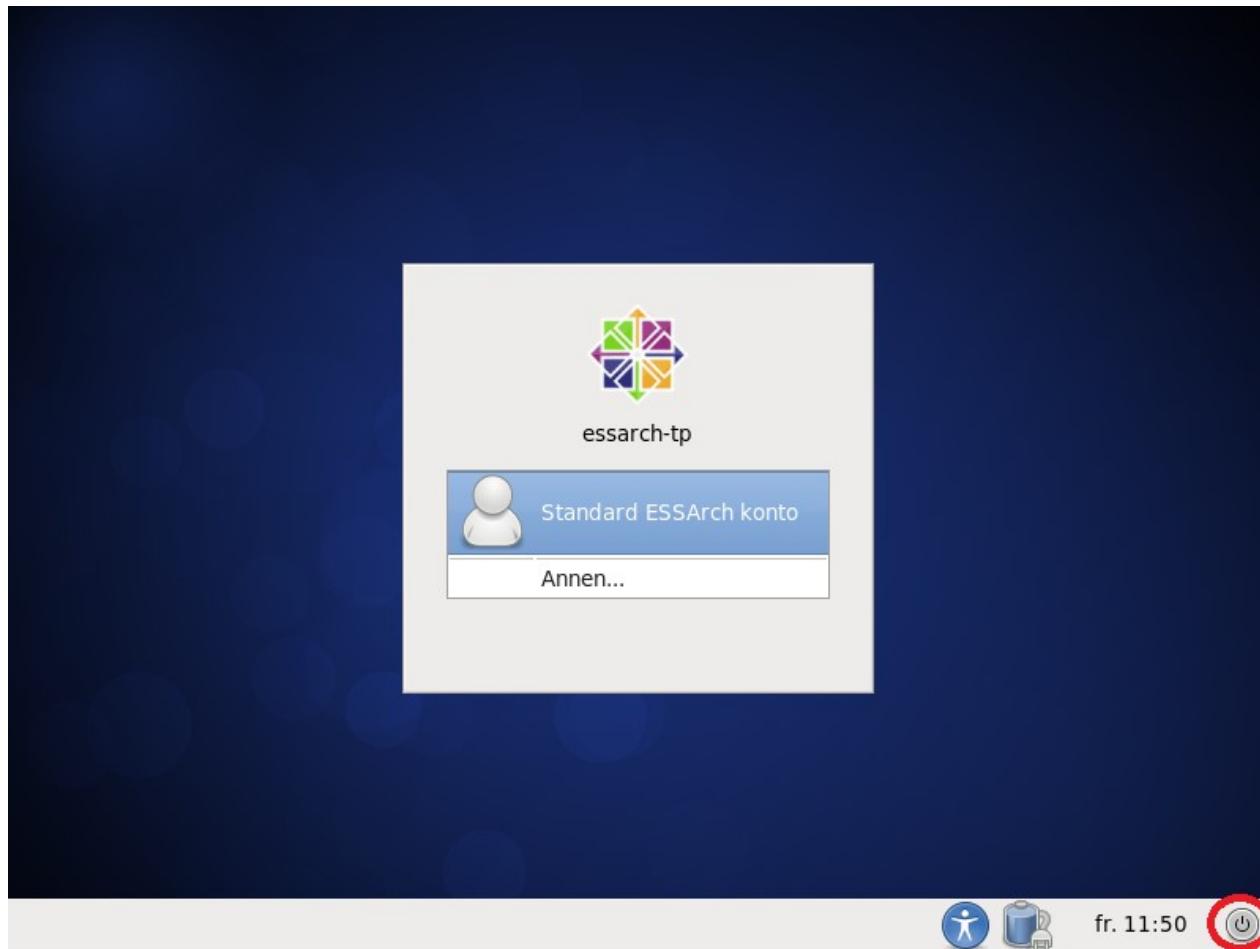

Avslutning del 2

I denne sesjonen har vi tatt for oss:

- Etablering av VMer for ETP og ETA i VirtualBox.
- Nødvendige tilpassninger av ETP og ETA til vårt miljø.
- Nedstenging av ETP og ETA VMer.

